

NOTE 1)

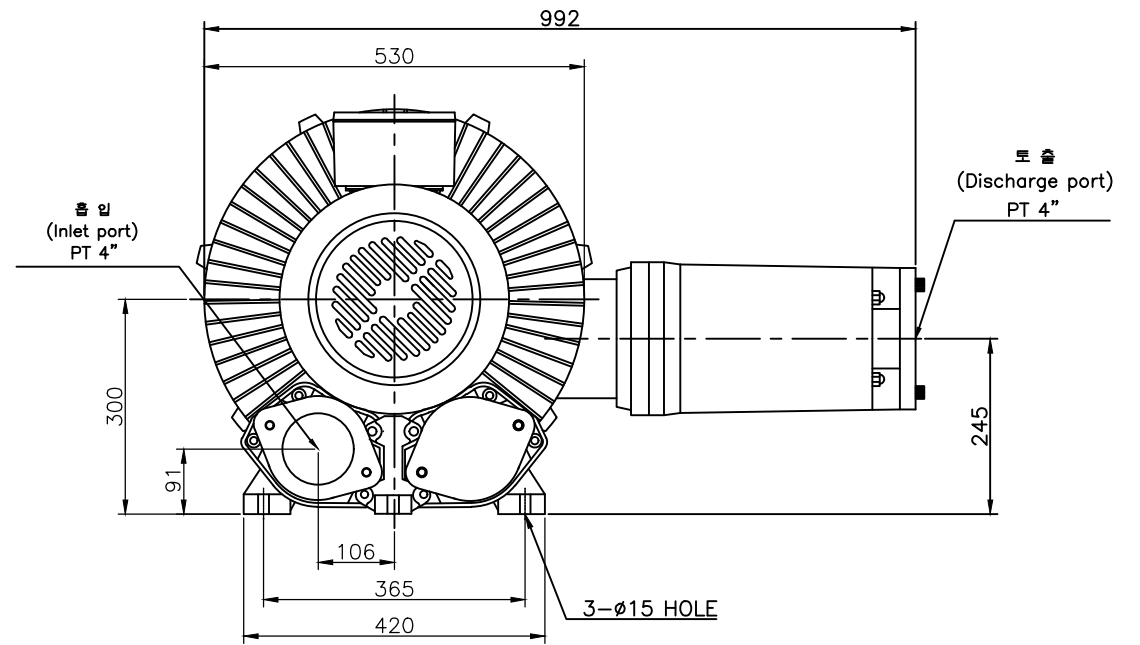
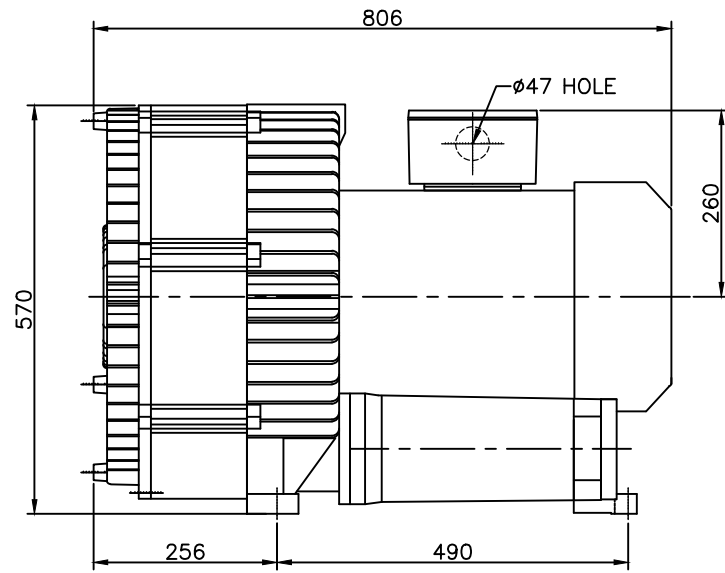

△						00			
No.	Revision					Date	Draw	Check	Appr.
형식 TYPE	HRB-1502MP		도명 TITLE	OUTWARD DWG.					
DRAWN	DESIGN	CHECKED	APPROVED	3RD ANGLE	SCALE:1/1	UNIT:mm			
B.S.Kim				SIZE	3 $\phi$ 2P 25.8Kw				
17.03.09									
黃海電機 HWANG HAE ELECTRIC				도번 DWG. No	BOD00255		△		